

INSTALLATION, OPERATION & MAINTENANCE GUIDE



STYLE 40/42/45



Headquarters

291 Hurricane Lane
Williston, VT 05495

TEL: (802) 878-8307
FAX: (802) 878-2479

Brazil

Rua Javaés, 441/443
Bom Retiro, Sao Paulo
Brazil CEP 01130-010

TEL: 55-11-3736-7373
FAX: 55-11-3736-7355

Gulf Coast

1719 South Sonny Avenue
Gonzales, LA 70737

TEL: (225) 484-0007
FAX: (225) 341-8922

Texas

Houston
7545 E. Orem Drive
Houston, TX 77075
TEL: (832) 804-7424

Odessa
801 S. Pagewood Avenue
Suite 2, Odessa, TX 79761
TEL: (432) 300-0167

REVISED: September 2022



OVERVIEW

This guide outlines the installation, operation and maintenance of the Style 40/42/45 rotary bellows head assembly. This guide, in addition to the manuals provided by the pump manufacturer and the manufacturer of any auxiliary equipment, should be read in its entirety prior to installation.

NOTICE

Flexaseal does not assume responsibility for misuse, or any damages incurred as a result of the misuse of the supplied sealing system. Contact a Flexaseal representative before making any changes to the provided system or design.

SAFETY

1. Read all instructions thoroughly prior to beginning installation.
2. Removal, installation, operation, and maintenance must only be carried out by qualified personnel who have thoroughly read all instructions.
3. The seal must only be used for its intended application. Flexaseal cannot be held liable for use outside the scope of the recommended application.
4. Inspect the replacement seal prior to removal of the old seal or installation of the new seal using the technical information provided in this document. Contact a Flexaseal representative if there are any questions.
5. Follow plant safety regulations and procedures throughout the disassembly/installation process including, but not limited to, the following:
 - Lockout/tagout procedures
 - SDS consultation for any hazardous materials involved
 - Use of proper personal protective equipment
 - Relief of any system pressure and mechanical energy
6. The following symbols have been used throughout the document to highlight important information:
 -  Instructions intended to prevent damage to the seal or equipment.
 -  Mandatory instructions intended to prevent personal injury or extensive damage to equipment.
 - NOTE:** Information to note while installing, or for later use.

Style 40/42/45 Maximum Operating Conditions

Temperature	400°F (204°C)
Pressure	300 psi (20 bar)
Speed	4500 fpm (22 m/s)

NOTE: Maximum temperature, pressure, and speed indicate operating extremes independently and do not imply the seal will function at these extremes at the same time. Contact Flexaseal if in doubt.

PREPARATION



Verify that equipment has been properly shut off and rendered inoperative according to plant safety protocol (e.g. lockout/tagout procedures).

1. Disassemble the pump seal chamber, in accordance with the pump OEM instructions, to expose the existing seal.

NOTE: Document how the seal chamber is disassembled for re-assembly.

2. Carefully remove the existing seal rotary and stationary assemblies, taking care not to damage the shaft or seat counterbore.
3. Clean the shaft, shaft sleeve (if present), seal chamber face, and seat counterbore surfaces

of rust, burrs, grit, sharp edges, and set screw damage using fine emery cloth. Wipe clean.

ATTENTION

Avoid making flat spots, reducing shaft diameter, or increasing seat bore diameter.

4. If the pump is equipped with a shaft sleeve, verify the condition of its O-ring or gasket and ensure that it is properly located (fully engaged against step/hook/snap ring).
5. Sealing surfaces and the shaft or shaft sleeve must have at least a 63 Ra- μ m surface finish as seen in [Figure 1](#).
6. For ease of installation, the leading edge of the shaft or sleeve should be chamfered as shown in [Figure 1](#) and all parts should be deburred.

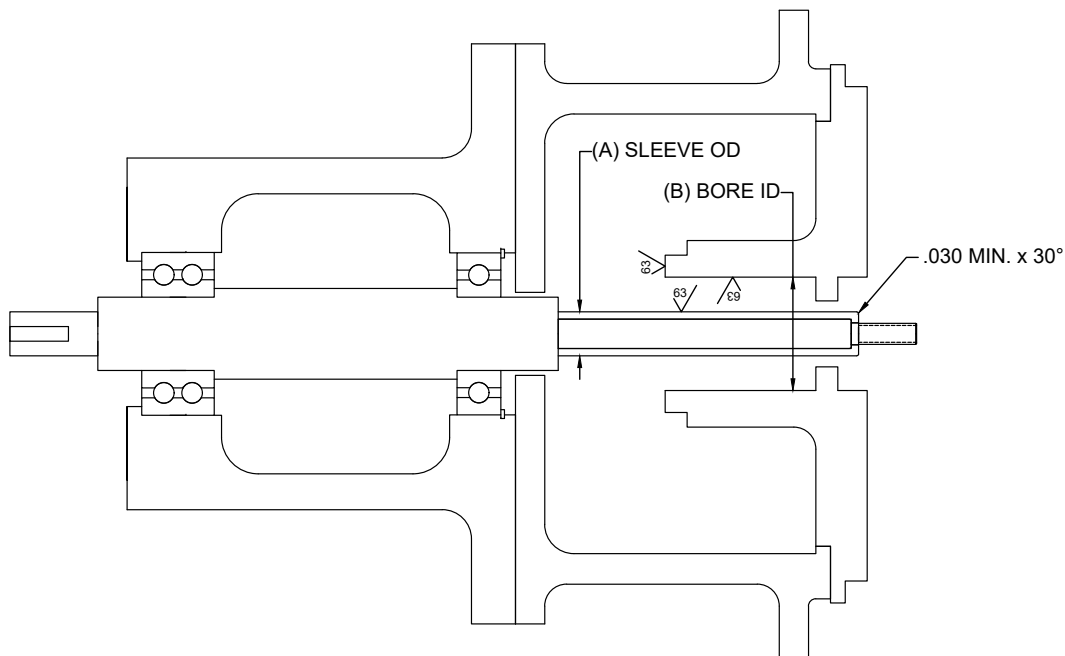

Figure 1: Surface finish and chamfer locations. Fully assembled pump without seal.

VERIFICATION

Successful operation of a Style 40/42/45 rotating welded metal bellows head is contingent on conforming equipment dimensions and alignment. Verify the following prior to continuing:

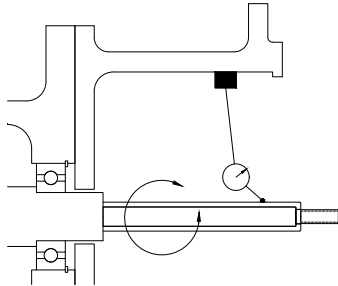

Figure 2: Shaft Runout

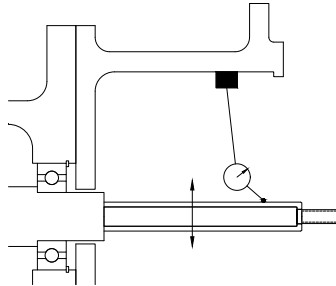

Figure 3: Bearing Fit

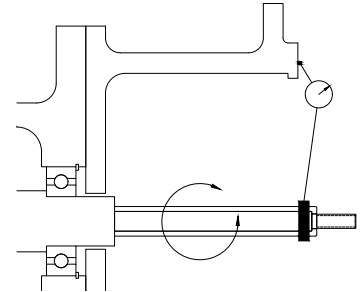

Figure 4: Bearing Frame Perpendicularity

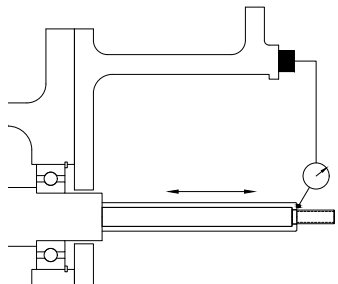

Figure 5: Axial Shaft Movement

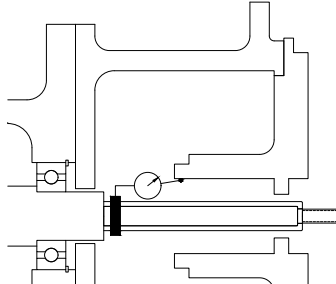

Figure 6: Seal Chamber Bore Concentricity

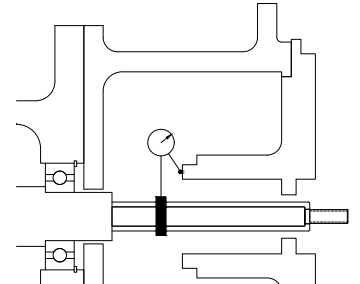

Figure 7: Seal Chamber Face Squareness

Maximum Alignment Variation (TIR)

Fig. 2	Radial shaft movement (shaft runout)	0.0015–0.003 in.
Fig. 3	Radial bearing fit	0.002–0.003 in.
Fig. 4	Bearing frame perpendicularity	0.0005 in./in.
Fig. 5	Axial shaft movement (end play)	0.003 in.
Fig. 6	Seal chamber bore concentricity	0.005 in.
Fig. 7	Seal chamber face squareness	0.0005 in./in.

For proper function and satisfactory operation of the seal it is imperative that connections, dimensions, finishes, and alignments are all acceptable based on the specified design. If measured values exceed the values given above, adjust the equipment to meet the specifications before installing the seal. These values are general guidelines and the pump OEM should be used to verify acceptable values whenever possible.

LAYOUT

NOTE: If the seal is being installed on equipment without a preset step, snap ring groove, etc. use the procedure described below to mark the reference distance (using values found on Pages 9 and 10), otherwise this section can be used to verify the distance of the existing geometry. Ensure that the seal's shaft O-ring is not mounted on any part of a step or groove prior to final installation.

NOTE: This procedure is designed for **inside-mounted seals**. For outside-mounted seals simply measure back from the chamber face towards the bearing frame for the setting distance. Be sure to account for mating ring and/or gland length for the setting length.

ATTENTION Do not scratch the shaft or sleeve when scribing during the layout procedure.

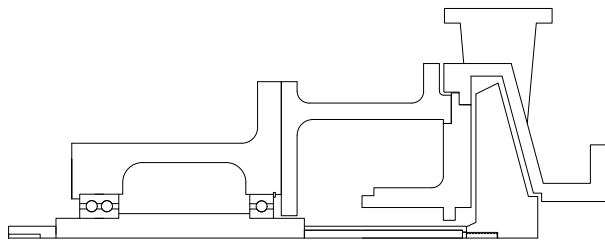

Figure 8: Fully assembled pump without seal

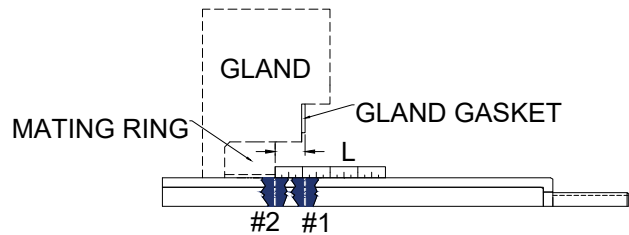

Figure 10: Measure seal face location

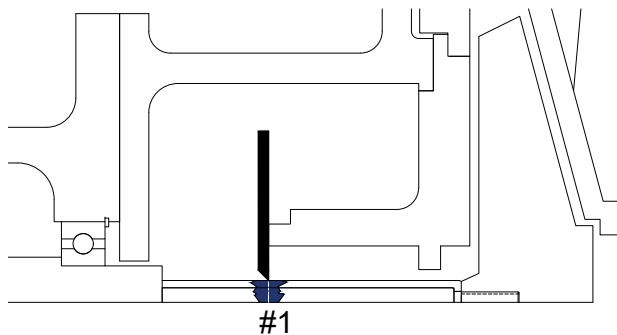

Figure 9: Layout dye application and scribe

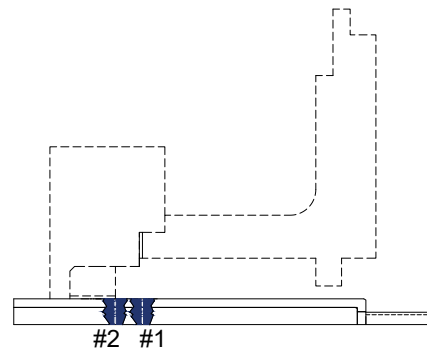

Figure 11: Scribe location of seal face

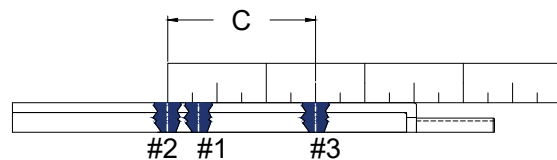

Figure 12: Setting length scribe

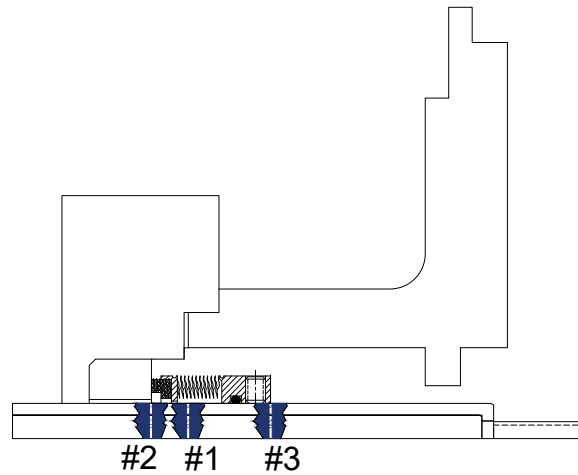

Figure 13: Assembled seal chamber

To scribe the correct locations for the component seal setting length use the following procedure:

1. Reassemble the pump, including the shaft sleeve, seal chamber cover, and impeller as shown in [Figure 8](#). After adjusting the impeller, apply layout dye to the shaft (or shaft sleeve) at the face of the seal chamber, and scribe a line in the dye showing the location of the chamber face as shown in [Figure 9](#).
2. Measure the distance from the stationary mating ring face to the seal chamber face. This can be accomplished by simply measuring the distance from the top of the gland gasket to the mating ring as seen in [Figure 10](#). The future location of Line #2 is shown as a reference for the reader.
3. Disassemble the pump and apply layout dye at the approximate location of the seal face. Measure the seal face distance (L) from Line #1 and scribe Line #2 into the dye as shown in [Figure 11](#).
4. From the seal face location, measure back along the shaft to the specified operating length (C) and scribe a third line (Line #3, [Figure 12](#)).

SEAL INSTALLATION

The following steps are for the installation of **inside-mounted** seals. Complete the layout and marking of the shaft for installation as described earlier before beginning installation. A complete **inside-mounted** assembly should resemble [Figure 13](#).



Grease, scratches, or nicks on the seal faces may cause leakage.

NOTE: It is essential to use a suitable lubricant when installing a seal, as different lubricants will work better with different elastomers.

1. Remove the seal from its packaging and inspect for damage to any components and seal faces.

2. Ensure the shaft and seal housing have been properly cleaned as described in the preparation section.
3. Evenly press the mating ring into the gland. Be careful to keep the face clean and use a suitable and compatible cleaning solvent if the face gets smudged or dirty.

- Gently position the gland with installed mating ring on the shaft facing, but clear of, the seal chamber.



Be careful to not damage the mating ring while setting the gland into position.

- Lightly lubricate the shaft with a suitable and compatible lubricant. Slide the seal on the shaft facing the bearing housing.
- Position the back of the rotary head assembly to line up with the setting length scribe line.
- Fix the seal in position by alternately tightening the provided set screws to the specified torque value according to the table below.
- Ensure the seal faces are clean and dry using a suitable and compatible cleaning solvent for the face material and elastomers.
- Reassemble the pump according to OEM specifications.
- Bring the gland with the mating ring installed into position and make sure that it mounts concentric to the shaft.
- Bolt the gland to the seal chamber using the Legacy Method (Star Pattern) according to torque requirements specified in the pump OEM. If they are not specified then tension the bolts using the Legacy Method in even 1/4 turn

increments until a gland seal is achieved. Be sure not to overtighten the gland bolts as this may distort the gland and mating ring resulting in seal leakage.

The following steps are for the installation of **outside-mounted** seals. Only special, rebalanced Style 40/42/45 seals are to be used in the outside mounted configuration.

- Follow steps **1.**, **2.**, and **3.** from the inside-mounted seal installation procedure.
- Lightly lubricate the shaft with a suitable and compatible lubricant. Slide the seal on the shaft with the seal face oriented towards the impeller.
- Mount the mating ring, gasketing, or other secondary seals to the seal chamber. Be sure that the lapped face is facing outward toward the seal assembly face.
- See step **11.** for inside-mounted seals.
- See step **9.** for inside-mounted seals.
- Bring the gland/seal chamber assembly into position on the pump, making sure not to damage the mating ring face.
- Bring the seal assembly into position with the reference scribe.
- See step **7.** for inside-mounted seals.

Cup Point Set Screw Torque Specifications

Screw Size	Alloy Steel	Stainless	Screw Size	Alloy Steel	Stainless
#10	36 in.-lbs.	26 in.-lbs.	M4	2.0 N-m	1.5 N-m
1/4	87 in.-lbs.	70 in.-lbs.	M6	7.9 N-m	6.1 N-m
5/16	165 in.-lbs.	130 in.-lbs.	M8	19.6 N-m	15.4 N-m
3/8	290 in.-lbs.	230 in.-lbs.	M10	37.0 N-m	29.5 N-m
1/2	620 in.-lbs.	500 in.-lbs.	M12	60.3 N-m	48.3 N-m

BEFORE STARTING THE EQUIPMENT

1. Ensure the pump shaft is properly aligned at the coupling with the motor.
 2. Check that all gland plate bolts and all screws are securely fastened.
 3. Once the pump is reassembled, turn the shaft by hand if possible to check for free rotation, if not, recheck installation.
 4. Verify that all plumbing and piping plans for the seal are connected and configured according to best practice.
 5. Flood the pump, vent all air from the seal chamber, and check the seal for leakage.
 6. Ensure all plumbing and venting are free of obstruction and that the chamber is filled with liquid. Check that all alarms connected to auxiliary systems are properly functioning to alert personnel if any issues arise.
- ATTENTION** Dry-running is a major cause for leakage and/or failure of mechanical seals. It is imperative that the seal chamber be completely vented prior to startup and that adequate lubrication is supplied to the seal.
7. Start the pump per the pump manufacturer's recommendations, observe for proper operation, and check for excessive heat at the seal gland.
- ATTENTION** Check periodically during operation to ensure that the seal is not overheating.

OPERATION & MAINTENANCE

If leakage is detected, it should be addressed as soon as possible to prevent hazards and protect personnel. Leakage could come from a number of leak paths in the seal, or be caused by changes in the pump operation or condition. Although seals should be inspected regularly for signs of leakage, a properly selected and functioning mechanical seal will run for extended durations without need for extra attention and should not be disturbed unnecessarily (i.e. shut down and disassembled without cause). Below is an inexhaustive list of possible causes of leakage.

Primary Causes

- Worn seal faces
- Damaged bellows
- Damaged O-rings

Secondary Causes

- Change in duty conditions
- Dry-running
- Worn bearings
- Increased vibration

It is important to periodically inspect and maintain flush systems, shaft alignment, and consistent duty parameters to ensure the seal performs as designed. Often, there is a case of cause & effect with machinery and processing issues upstream that can cause a seal to leak. Check for the root cause of leakage when disassembling equipment for inspection or service.

DECOMMISSIONING EQUIPMENT

When decommissioning equipment it is important to ensure that the pump has been fully isolated from the process and power sources for personnel safety. Pressure and fluid should be fully released before disassembly of the equipment is to begin.



If the equipment has been used with toxic or hazardous fluids, ensure that it is decontaminated and neutralized before decommission begins. There is often residual fluid remaining from the draining process so consult the pump OEM for special cases.

REMOVING THE SEAL



Before opening the pump to remove the seal the warning stated above regarding toxins and hazardous products must be reiterated. Make note of all fluids contained in the pump, drain and decontaminate before opening the housing for seal service.

1. Ensure all fluid has been drained and vented. Equipment should be shut down and locked/tagged out according to OEM and plant specifications.
2. Dismantle the equipment sufficiently so that the gland plate and seal housing are exposed and accessible for service.
3. Remove the gland nuts/bolts in an even manner and set the gland plate aside.
4. Remove the seal in the reverse manner of how it was installed.

NOTE:

It is important to check the scribe reference each time a seal is re-installed even if the same components are being re-installed.



If a part is going to be returned for service or to any third party, all shipments should have appropriate safe-handling instructions securely attached to the package.

DIMENSIONAL DATA (INCH)

SIZE	A	B	C	D	O-RING
-12	.750	1.312	1.250	.120	-116
-13X	.812	1.457	1.250	.120	-117
-14X	.875	1.457	1.250	.120	-118
-15X	.938	1.457	1.250	.120	-119
-16X	1.000	1.457	1.250	.120	-120
-17	1.062	1.687	1.250	.120	-121
-18	1.125	1.687	1.250	.120	-122
-20	1.250	1.812	1.312	.120	-124
-20X	1.250	1.694	1.312	.120	-124
-22	1.375	1.937	1.437	.120	-126
-24	1.500	2.062	1.437	.120	-128
-24X	1.500	1.944	1.437	.120	-128
-26	1.625	2.187	1.437	.120	-130
-28	1.750	2.312	1.437	.120	-132
-30	1.875	2.437	1.500	.120	-134
-32	2.000	2.562	1.500	.120	-226
-34	2.125	2.687	1.500	.120	-138
-36	2.250	2.812	1.562	.120	-140
-38	2.375	2.937	1.562	.120	-142
-40	2.500	3.187	1.562	.120	-144
-42	2.625	3.312	1.625	.120	-146
-44	2.750	3.437	1.625	.120	-148
-46	2.875	3.625	1.687	.120	-150
-48	3.000	3.750	1.687	.120	-151
-50	3.125	3.875	1.750	.120	-235
-52	3.250	4.000	1.750	.120	-236
-54	3.375	4.125	1.750	.120	-237
-56	3.500	4.250	1.875	.120	-238
-58	3.625	4.375	1.875	.120	-239
-60	3.750	4.500	1.875	.120	-240
-62	3.875	4.625	1.875	.120	-241
-64	4.000	4.750	1.875	.120	-242
-66	4.125	5.125	1.875	.125	-243
-68	4.250	5.125	1.875	.125	-244
-70	4.375	5.375	1.875	.125	-245
-72	4.500	5.375	1.875	.125	-246
-74	4.625	5.625	1.875	.125	-247
-76	4.750	5.625	1.875	.125	-248
-80	5.000	5.875	1.875	.125	-250
-84	5.250	6.125	1.875	.125	-252
-88					
-92	5.750	6.625	1.875	.125	-256
-96					
-100					
-104	6.500	7.375	2.000	.125	-363
-108					
-112	7.000	7.875	2.000	.125	-365

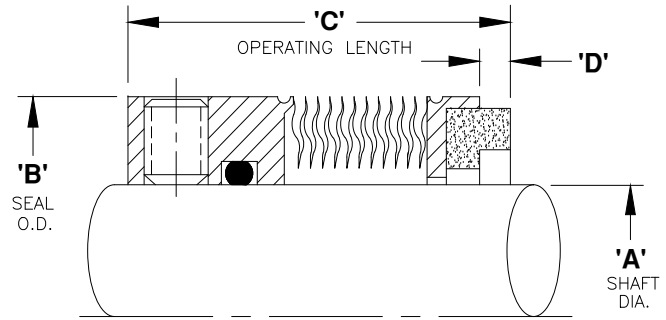

Materials of Construction:

Standard Metallurgy:

- **Type 40:** -316 End Fittings with AM350 Bellows
- **Type 42:** -316 S.S. End Fittings with Hastelloy® C Bellows
- **Type 45:** -Hastelloy® C End Fittings and Bellows

Standard Face Materials: Carbon, Nickel Bound Tungsten Carbide, Silicon Carbide, Antimony Impregnated Carbon.

Secondary Seal Packaging: Viton®(*), Buna, Aflas®(**), Chemraz®(***), PTFE Jacketed Viton, Ethylene Propylene, Kalrez®(*), Solid PTFE

Other materials available upon request.

* [Reg. Trademark of Dupont Performance Elastomers LLC.]

** [Reg. Trademark of Asahi Glass Co.]

*** [Reg. Trademark of Greene Tweed Co.]

Hastelloy [Reg. Trademark of Haynes International Inc.]

DIMENSIONAL DATA (METRIC)

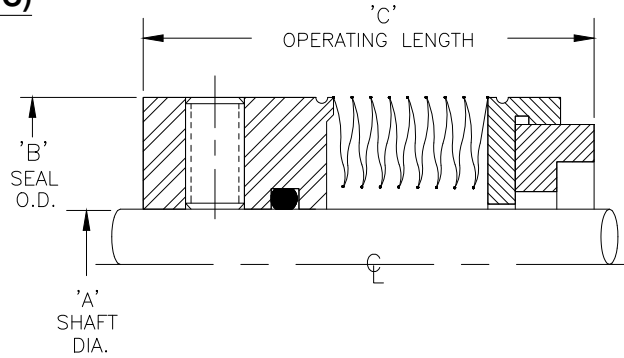

SHAFT "A"	BELLOWS SIZE	O.D. "B"	INSTALL LG. "C"	O-RING P/N
.984 (25)	-16x	1.457 (37)	1.250 (31.8)	-120
1.102 (28)	-18	1.687 (42.8)	1.250 (31.8)	-122
1.181 (30)	-20x	1.694 (43)	1.312 (33.3)	-123
1.260 (32)	-20x	1.694 (43)	1.312 (33.3)	-124
1.299 (33)	-22	1.937 (49.2)	1.437 (36.5)	-125
1.378 (35)	-22	1.937 (49.2)	1.437 (36.5)	-126
1.496 (38)	-24x	1.944 (49.4)	1.437 (36.5)	-128
1.575 (40)	-26	2.187 (55.5)	1.437 (36.5)	-129
1.693 (43)	-28	2.312 (58.7)	1.437 (36.5)	-131
1.772 (45)	-28	2.312 (58.7)	1.437 (36.5)	-132
1.890 (48)	-30	2.437 (61.9)	1.500 (38.1)	-134
1.969 (50)	-32	2.562 (65.1)	1.500 (38.1)	-136
2.087 (53)	-34	2.687 (68.2)	1.500 (38.1)	-137
2.165 (55)	-36	2.812 (71.4)	1.562 (39.7)	-139
2.362 (60)	-38	2.937 (74.6)	1.562 (39.7)	-142
2.480 (63)	-40	3.187 (80.9)	1.562 (39.7)	-144
2.559 (65)	-42	3.312 (84.1)	1.625 (41.3)	-145
2.756 (70)	-44	3.437 (87.3)	1.625 (41.3)	-148
2.953 (75)	-46	3.625 (92.1)	1.687 (42.8)	-151
3.150 (80)	-50	3.875 (98.4)	1.750 (44.5)	-235
3.346 (85)	-54	4.125 (104.8)	1.750 (44.5)	-237
3.543 (90)	-56	4.250 (108)	1.875 (47.6)	-239
3.740 (95)	-60	4.500 (114.3)	1.875 (47.6)	-240
3.937 (100)	-64	4.750 (120.7)	1.875 (47.6)	-242
4.134 (105)	-68	5.125 (130)	1.875 (47.6)	-243
4.331 (110)	-68	5.125 (130)	1.875 (47.6)	-245
	-72			
4.724 (120)	-76	5.625 (142.9)	1.875 (47.6)	-248
	-80			
	-84			
	-88			
	-92			
	-96			
	-100			
6.496 (165)	-104	7.375 (187.3)	2.000 (50.8)	-363
	-108			
	-112			

Dimensions in parentheses are metric (mm).

LIMITED WARRANTY AND LIMITATION OF LIABILITY:

SEAL PRODUCTS



Flexaseal Engineered Seals and Systems, LLC (hereinafter referred to as "FAS") warrants that new goods manufactured by FAS (with the exception of "wear parts" or consumables all of which are not warranted) will be free from defects in material and workmanship (the "Warranty"). The Warranty shall be in effect for a period of the earlier of three (3) months from the date of installation or six (6) months from the date of shipment from FAS's facility (which date of shipment shall not be greater than thirty (30) days after receipt of notice that the goods are ready to ship) (the "Warranty Period"). FAS shall, at its option and expense, either repair, replace, or refund amounts paid for any goods that fail to conform to the Warranty. In no case shall FAS be obligated to remove the defective goods or install the replaced or repaired goods, and the end user shall be responsible for providing ready access to the goods and areas for warranty work, and all other associated costs, including, but not limited to, service costs, shipping fees, and expenses. FAS shall have complete discretion as to the method or means of repair or replacement. The end user's failure to comply with FAS's repair or replacement directions shall constitute a waiver of its rights and render all warranties void. Any goods repaired or replaced under the Warranty are warranted only for the balance of the Warranty Period on the goods that were repaired or replaced. The Warranty is conditioned on the end user giving written notice to FAS of any goods that fail to meet the Warranty within ten (10) days of the date when any defects first become apparent. FAS shall have no warranty obligations to the end user with respect to any goods or parts of a good that: (a) have been repaired by parties other than FAS or without FAS's written approval; (b) have been subject to misuse, misapplication, neglect, alteration, accident, or physical damage; (c) have been used in a manner contrary to FAS's instructions for installation, operation and maintenance; (d) have been damaged from ordinary wear and tear, corrosion, or chemical attack; (e) have been damaged due to abnormal conditions, vibration, failure to properly prime, or operation without flow; (f) have been damaged due to a defective power supply or improper electrical protection; or (g) have been damaged resulting from the use of accessory Products not sold by FAS or not approved by FAS in connection with goods supplied by FAS.

THE FOREGOING WARRANTY IS EXCLUSIVE AND IN LIEU OF ANY AND ALL OTHER EXPRESS, ORAL, OR IMPLIED WARRANTIES, GUARANTEES, CONDITIONS OR TERMS OF WHATEVER NATURE RELATING TO THE GOODS PROVIDED HERewith, INCLUDING WITHOUT LIMITATION, ANY IMPLIED WARRANTIES OF MERCHANTABILITY AND FITNESS FOR A PARTICULAR PURPOSE, WHICH ARE HEREBY EXPRESSLY DISCLAIMED AND EXCLUDED. END USER'S EXCLUSIVE REMEDY AND FAS'S AGGREGATE LIABILITY FOR BREACH OF ANY OF THE FOREGOING WARRANTIES ARE LIMITED TO THE REPAIR, REPLACEMENT, REPERFORMANCE, OR REFUND.

IN NO EVENT SHALL FAS'S LIABILITY ARISING OUT OF OR IN ANY WAY RELATED TO THE GOODS EXCEED THE AMOUNT PAID BY END USER UNDER THIS AGREEMENT. FAS SHALL HAVE NO LIABILITY FOR LOSS OF PROFIT, LOSS OF ANTICIPATED SAVINGS OR REVENUE, LOSS OF INCOME, LOSS OF BUSINESS, LOSS OF PRODUCTION, LOSS OF OPPORTUNITY, LOSS OF USE, LOSS OF REPUTATION, BUSINESS INTERRUPTION, DOWNTIME, INDIRECT, CONSEQUENTIAL, INCIDENTAL, PUNITIVE OR EXEMPLARY DAMAGES, HOWSOEVER ARISING, WHETHER IN WARRANTY, CONTRACT, TORT, PRODUCT LIABILITY, STRICT LIABILITY, OR OTHERWISE, REGARDLESS OF WHETHER FAS HAS BEEN APPRISED OF THE POSSIBILITY OF SUCH LOSSES IN ADVANCE.

This warranty and limitation of liability shall be governed and construed in accordance with the laws of the State of Delaware, USA. Sole and exclusive venue for any claim or controversy arising out of or in any way related to this warranty and limitation of liability shall be in a state court located in Chittenden County, Vermont, USA.

www.flexaseal.com

Vermont	Brazil	Louisiana	Texas
800.426.3594	55.11.3736.737	225.484.0007	832.804.7424

**FAS SW
V2.2020**